

Installation and Operation Guide

V672-W HD Analog Box Cameras



XX299-20



Vicon Industries Inc. does not warrant that the functions contained in this equipment will meet your requirements or that the operation will be entirely error free or perform precisely as described in the documentation. This system has not been designed to be used in life-critical situations and must not be used for this purpose.

Document Number: 8009-8299-20-00
Product specifications subject to change without notice.
Issued: 2/17 Copyright © 2017 Vicon Industries Inc. All rights reserved.

Vicon Industries Inc.
Tel: 631-952-2288) Fax: 631-951-2288
Toll Free: 800-645-9116
24-Hour Technical Support: 800-34-VICON
(800-348-4266) UK: 44/(0) 1489-566300
www.vicon-security.com

FCC COMPLIANCE STATEMENT

This device complies with Part 15 of the FCC Rules. Operation is subject to the following two conditions: (1) this device may not cause harmful interference, and (2) this device must accept any interference received, including interference that may cause undesired operation.

FCC INFORMATION: This equipment has been tested and found to comply with the limits for a Class A digital device, pursuant to Part 15 of the FCC Rules. These limits are designed to provide reasonable protection against harmful interference when the equipment is operated in a commercial environment. This equipment generates, uses, and can radiate radio frequency energy and, if not installed and used in accordance with the instruction manual, may cause harmful interference to radio communications. Operation of this equipment in a residential area is likely to cause harmful interference in which case the user will be required to correct the interference at his own expense.

CAUTION: Changes or modifications not expressly approved by the party responsible for compliance could void the user's authority to operate the equipment.

CE COMPLIANCE STATEMENT

WARNING: This is a Class A product. In a domestic environment this product may cause radio interference in which case the user may be required to take adequate measures.

IMPORTANT SAFETY INSTRUCTIONS

1. Read these instructions.
2. Keep these instructions.
3. Heed all warnings.
4. Follow all instructions.
5. Do not block any ventilation openings. Install in accordance with the manufacturer's instructions.
6. Do not install near any heat sources such as radiators, heat registers, stoves, or other apparatus (including amplifiers) that produce heat.
7. Only use attachments/accessories specified by the manufacturer.
8. Use only with the cart, stand, tripod, bracket, or table specified by The manufacturer, or sold with the apparatus. When a cart is used, Use caution when moving the cart/ apparatus combination to avoid Injury from tip-over.
9. **CAUTION – THESE SERVICING INSTRUCTIONS ARE FOR USE BY QUALIFIED SERVICE PERSONNEL ONLY. TO REDUCE THE RISK OF ELECTRIC SHOCK DO NOT PERFORM ANY SERVICING OTHER THAN THAT CONTAINED IN THE OPERATING INSTRUCTIONS UNLESS YOU ARE QUALIFIED TO DO SO.**
10. **Use satisfy clause 2.5 of IEC60950-1/UL 60950-1 or Certified/Listed Class 2 power source only.**
11. Indoor use only.



EXPLANATION OF GRAPHICAL SYMBOLS



The lighting flash with arrowhead symbol, within an equilateral triangle, is Intended to alert the user to the presence of uninsulated “dangerous voltage” within the product’s enclosure that may be of sufficient magnitude to constitute a risk of electric shock to persons.



The exclamation point within an equilateral triangle is intended to alert the user to the presence of important operating and maintenance (servicing) instructions in the literature accompanying the appliance.

LIMITATION OF LIABILITY

THE INFORMATION IN THIS PUBLICATION IS BELIEVED TO BE ACCURATE IN ALL RESPECTS; HOWEVER, WE CANNOT ASSUME RESPONSIBILITY FOR ANY CONSEQUENCES RESULTING FROM THE USE THEREOF. THE INFORMATION CONTAINED HEREIN IS SUBJECT TO CHANGE WITHOUT NOTICE. REVISIONS OR NEW EDITIONS TO THIS PUBLICATION MAY BE ISSUED TO INCORPORATE SUCH CHANGES.

PRECAUTIONS

Before installation, carefully read the manual to ensure correct operation and setup, heeding all warnings and instructions.

Do not block any ventilation openings. Install in accordance with the manufacturer's instructions.

Ensure manual is kept in good condition for future use.

Do not install the device near any heat sources such as radiators, heat registers, stoves, or other equipment(including amplifiers) that produce heat.

Only use attachments/accessories specified by the manufacturer.

Should any liquid get into the housing, immediately disconnect the device from the power supply and have it checked by authorized personnel before reusing.

Do not install the device in a place where it is exposed to gas or oil.

Installation and servicing by authorized personnel only, adhering to local safety regulations.

Unless you are an authorized technician, never try to dismantle the device. To avoid electric shock, never remove the screws or covers.

If a camera, do not expose the device to radioactivity. It will cause serious damage to the CCD.

Use Certified/Listed Class 2 power source only.

Cleaning

Clean the device with a slightly damp soft cloth. Use a mild household detergent. Never use strong solvents such as thinner or benzene as they might damage the finish of the unit.

TABLE OF CONTENTS

INTRODUCTION ----- 6

CONTENTS OF PACKAGE ----- 7

CAMERA OVERVIEW ----- 7

STRUCTURE OF THE SETUP MENU ----- 8

SPECIFICATIONS ----- 14

INSTRUCTION

The V672-W-NL full HD analog box camera provides high-quality images using CMOS technology especially for closed circuit television CCTV and security surveillance application.

Features:

- High performance Sony 1/2.8" 2.1M Starvis CMOS™
- Min. illumination 0.03 lux (DSS off)
- Auto electronic shutter [1/30(1/25) ~ 1/30,000] and manual electronic shutter modes
- True WDR (Wide Dynamic Range) in HD mode
- D-WDR (Digital Wide Dynamic Range) in composite video mode
- BLC (Backlight compensation)
- HLC (High light compensation)
- Auto and manual white balance modes (AUTO/AUTOext/Manual/AWB)
- Day & Night (ICR): Auto/Color/BW/EXTERN
- OSD (On Screen Display)
- DNR (Digital Noise Reduction)
- Privacy mask function (16 zones)
- Motion Detection (4 zones)
- Defog
- Composite Video Output (700 TV Lines)
- Operates in 24 VAC \pm 10% / 12 VDC \pm 10%
- Use Certified/Listed Class 2 Power source only



IMPORTANT: The user of this camera is responsible for checking and complying with local, state, and federal laws and statutes concerning the recording and monitoring of audio signals.

CONTENTS OF PACKAGE

Installation of the camera must be performed by qualified service personnel in accordance with all local and national electrical and mechanical codes.

Carefully remove the color camera and its accessories from the carton and verify that they were not damaged in shipment.

The content of the package includes:

1. Camera
2. This manual
3. L Wrench

CAMERA OVERVIEW

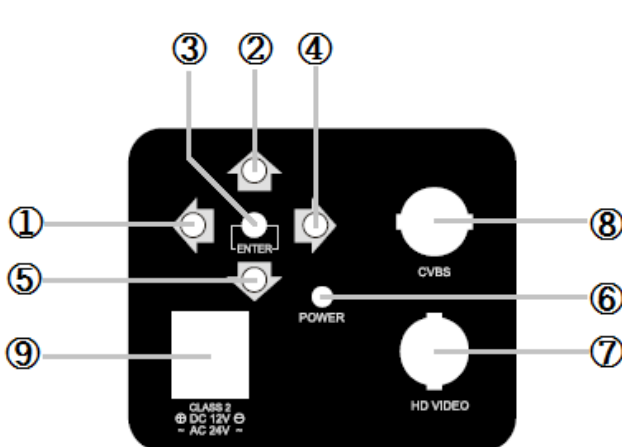
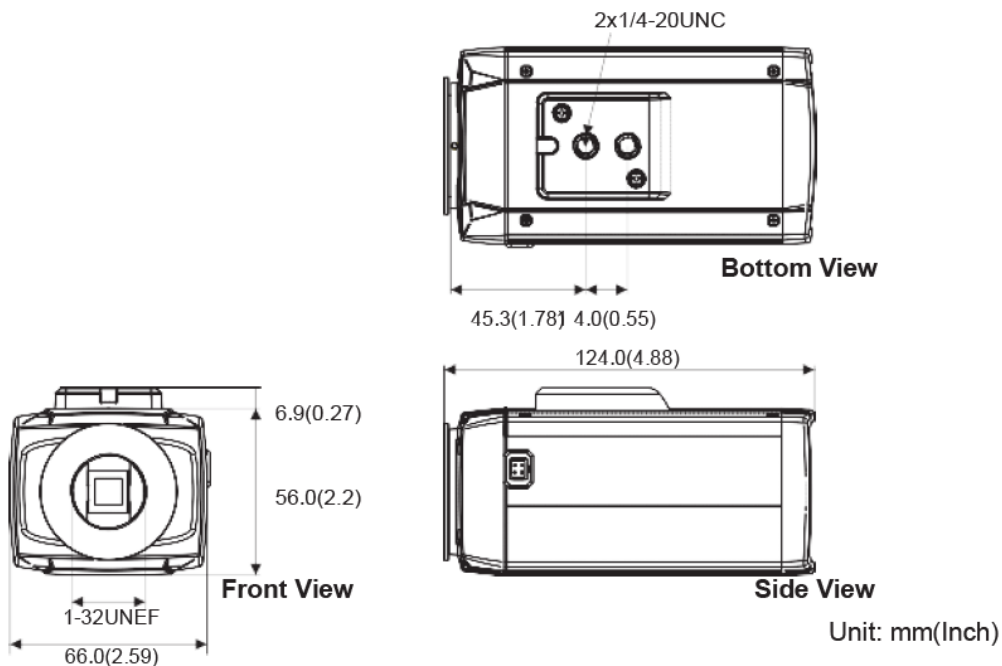

- ① Left Button
- ② Up Button
- ③ Enter Button
- ④ Right Button
- ⑤ Down Button
- ⑥ Power Indicator
- ⑦ HD-Video Out Connector (BNC)
- ⑧ CVBS Video Out Connector (BNC)
- ⑨ 24 VAC/12 VDC Input Terminal

STRUCTURE OF THE SETUP MENU

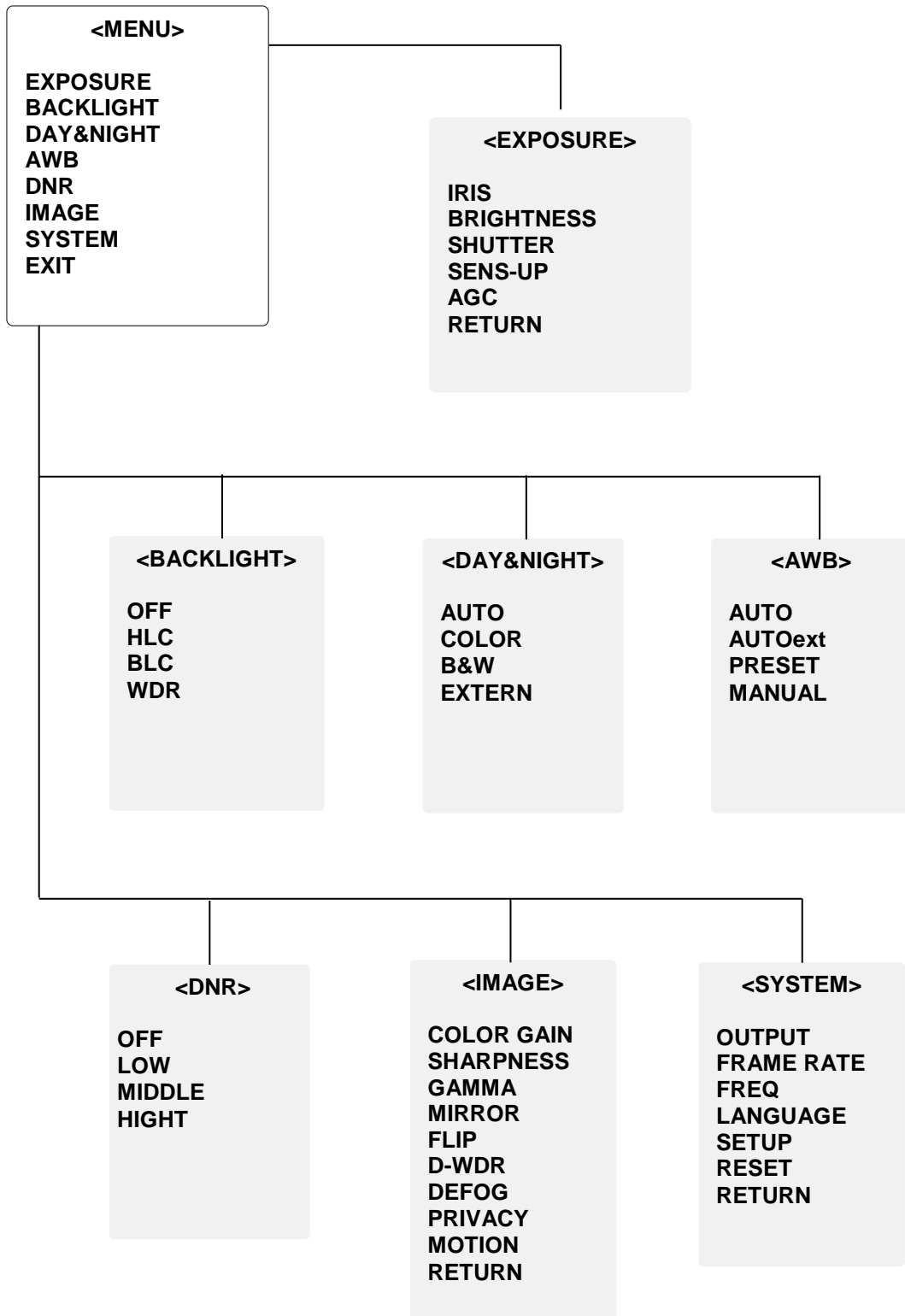

Use the joystick switch on the rear of the camera to navigate the setup menus. Use up or down to move the cursor to select the menu option, left or right to view setting options; press Enter to select.

EXPOSURE

The EXPOSURE menu is used to set the automatic light control method for the camera. It provides the ability to adjust the IRIS, BRIGHTNESS, SHUTTER speed, SENS-UP and AGC functions of the camera.

- 1) **IRIS** Select the IRIS mode: ▶ALC (DC), ELC (Manual)
- 2) **BRIGHTNESS** Adjust the BRIGHTNESS level: ▶ 0 - 20
- 3) **SHUTTER** Select the SHUTTER speed level:
 ☐Auto (INDOOR, OUTDOOR, DEBLUR), MANUAL 1/30(25) - 1/30000, FLICKER
- 4) **SENS-UP** Select the Digital Slow Shutter level: ▶OFF, x2 ~ x32
- 5) **AGC** Adjust the Auto Gain Control level: ☐0 - 10

<EXPOSURE> Mode

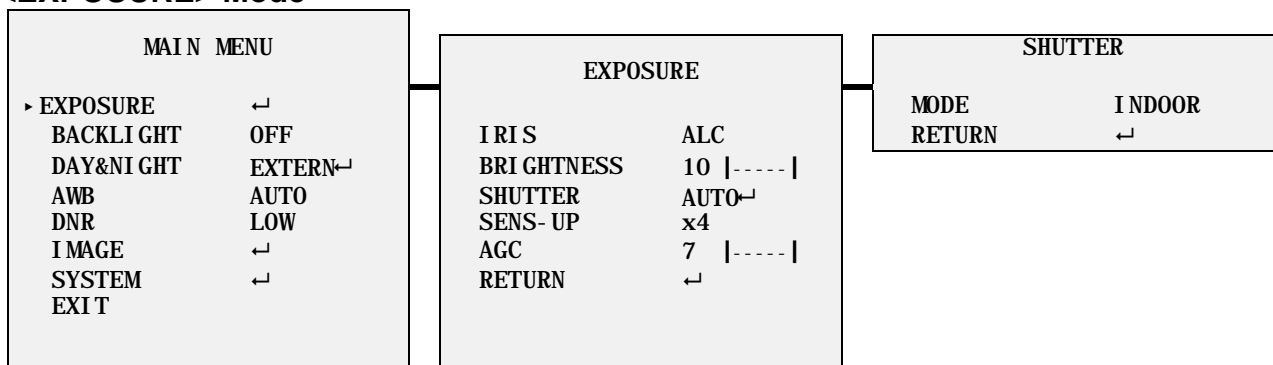

BACKLIGHT

The BACKLIGHT menu is used to prevent the loss of detail due to uneven lighting in the image.

- 1) **HLC**: Improves the ability to identify subjects in brightly lit situations by filtering out (masking) the strength of the light. Mask the high light zone with specific color and level.
 - LEVEL** Select the HLC level: ▶0 ~ 20
 - COLOR** Select the HLC area color:
 ▶BLK, CUSTOMIZE, WHT, YEL, CYN, GRN, MAG, RED, BLU

2) **BLC:** Compensates for a loss of detail on dark subjects due to backlighting by providing increased brightness on the overall scene. Adjust the position and size of Back Light Compensation area.

- H-POS** Adjust the BLC area window horizontal position: ►0 - 20
- V-POS** Adjust the BLC area window vertical position: ►0 - 20
- H-SIZE** Adjust the BLC area window horizontal size: ►0 - 20
- V-SIZE** Adjust the BLC area window vertical size: ►0 - 20

3) **WDR:** Expands the dynamic range light effect to secure a clear image under all illumination environments. True WDR in HD mode only.

- MODE** Select the WDR area: ► NORMAL, ROI
- WEIGHT** Adjust the WDR level: ► LOW, MIDDLE, HIGH

Note: When CVBS video is connected, the WDR function cannot be turned on.

<BACKLIGHT> Mode

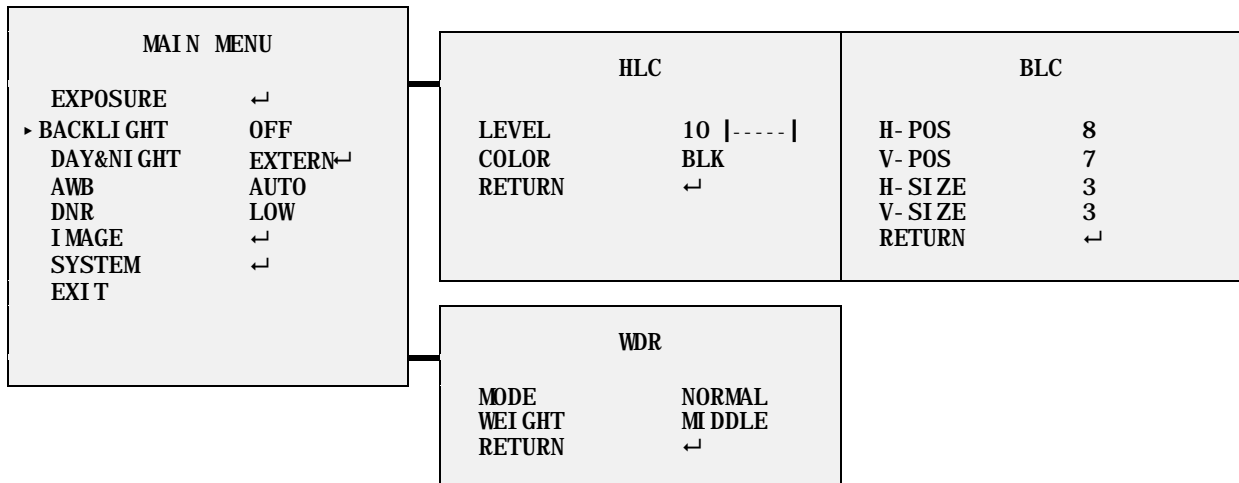

DAY&NIGHT

The DAY&NIGHT menu is used to configure how the camera handles color and changes between the day and night modes.

1) **EXTERN**

- ANTI-SAT.** Adjust levels of anti-saturation: ►0 - 20
- EXTERN SW** Adjust levels of external sensor: □ LOW, HIGH
- D>N THRES** Adjust levels of day to night transition: □ 0 - 20
- N>D THRES** Adjust levels of night to day transition: ►0 - 20
- DELAY** Adjust time of day to night mode transition:
►LOW, MIDDLE, HIGH

2) AUTO

- ANTI-SAT.** Adjust levels of anti-saturation: ▶0 - 20
- AGC THRES** Adjust levels of transition: ▶0 - 20
- AGC MARGIN** Adjust levels of transition: ▶0 - 20
- DELAY** Adjust time of day to night mode transition:
▶ LOW, MIDDLE, HIGH

DAY&NIGHT mode changes according to the brightness of the image. Use only when the camera is installed in a dark place but the camera is viewing a bright place. When used in a normal installation, hunting may occur.

3) COLOR

Select color to have the camera to display in color.

4) B&W

- ANTI-SAT.** Adjust levels of anti-saturation: ▶0 - 20

<DAY & NIGHT> Mode

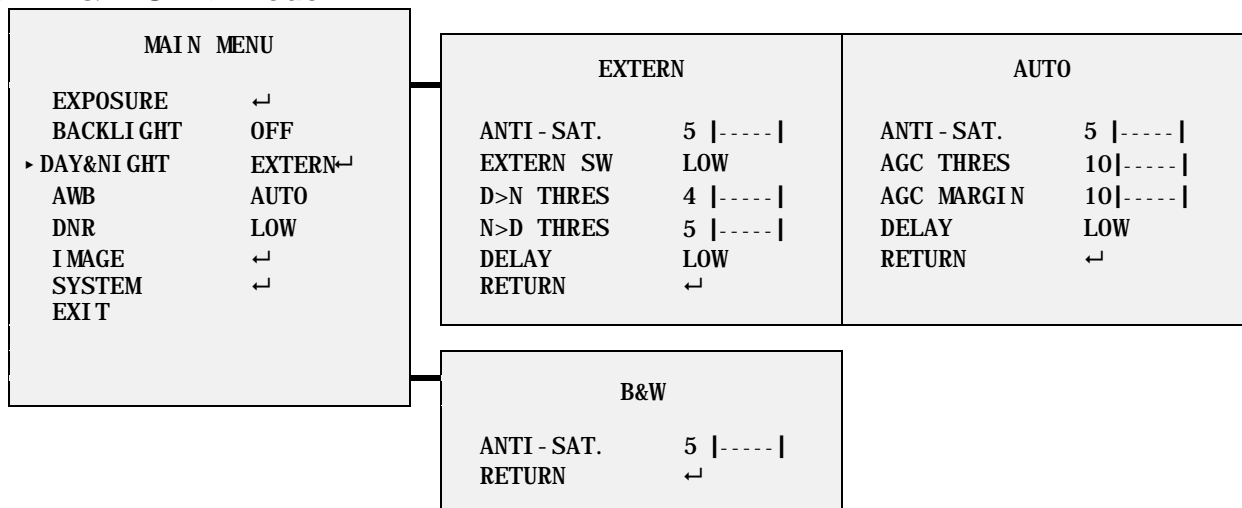

AWB

The screen color can be adjusted by using the Auto White Balance function. This compensates for deviations in the white color caused by changes in the color temperature of the light source so that the colors are reproduced correctly.

- 1) **AUTO** Automatically adjust indoor color temperature
- 2) **AUTOext** Automatically adjust outdoor color temperature
- 3) **PRESET** Automatically readjust by a simple press and hold until the desired auto white level is reached.
- 4) **MANUAL** Manual mode. User can change color temperature, Red and Blue gain value, manually.
 - C-TEMP** 3000°K, 5000°K, 8000°K
 - R-GAIN** 0 ~ 20
 - B-GAIN** 0 ~ 20

<WHITE BALANCE> Mode

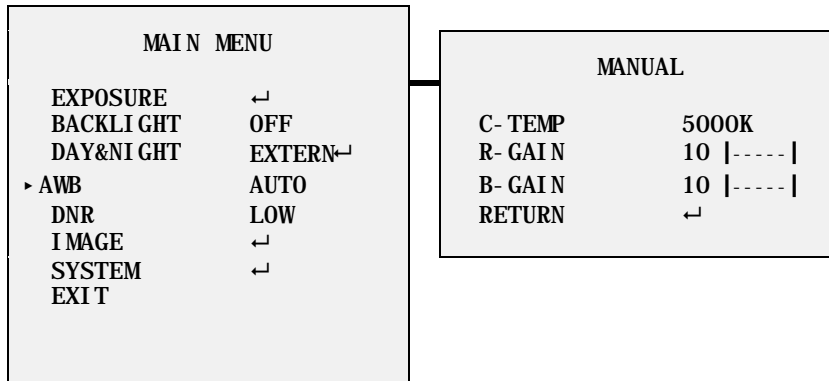

DNR

The DNR menu provides the ability to adjust the DNR (Digital Noise Reduction) functions of the camera.

1) **DNR** Select DNR: ▶ LOW, MIDDLE, HIGH

Note: When CVBS video is connected, the DNR function cannot be turned on.

IMAGE

The IMAGE menu provides the ability to adjust the COLOR GAIN, SHARPNESS, GAMMA, MIRROR, FLIP, D-WDR, DEFOG, PRIVACY and MOTION functions of the camera.

1) **COLOR GAIN** Adjust the Color Gain level: ▶0 - 20

2) **SHARPNESS** Adjust the Sharpness level: ▶0 - 10

3) **GAMMA** Select the Gamma level: ▶0.45, 0.55, 0.65, 0.75

4) **MIRROR** Select Mirror mode: ▶ON, OFF

5) **FLIP** Select Flip mode: ▶ON, OFF

6) **D-WDR** Select the Digital WDR: ▶OFF, LOW, MIDDLE, HIGH.
For composite video.

7) **DEFOG** Select the Defog mode: ▶OFF, ON

MODE: ▶AUTO, MANUAL

LEVEL: ▶LOW, MIDDLE, HIGH

8) **PRIVACY** Hide an area of a scene the user does not want to display: ▶OFF, ON

ZONE NUM Select the privacy zone: ▶AREA0 - AREA15

ZONE DISP Select the privacy zone display: ▶OFF, ON

H-POS Select the privacy zone horizontal position: ▶0 - 60

V-POS Select the privacy zone vertical position: ▶0 - 34

- H-SIZE** Select the privacy zone horizontal size: ▶0 - 60
- V-SIZE** Select the privacy zone vertical size: ▶0 - 34
- Y LEVEL** Select the privacy zone darkness: ▶0 - 20
- CB LEVEL** Select the privacy zone blue color: ▶0 - 20
- CR LEVEL** Select the privacy zone red color: ▶0 - 20
- TRANS** Select the privacy zone transparency: ▶0 - 3

9) MOTION

Select an area to detect motion object in the scene: ▶ ON, OFF

DET WINDOW Select the motion area: ▶AREA1 - AREA4

DET TONE Select the motion area transparency: ▶0 - 3

MDRECT FILL Select how the motion area is displayed:

▶ON, OFF. When On, the motion area box fills with transparent red when motion is detected; when Off, the box will just have a border.

SENSITIVITY Adjust the motion sensitivity level: ▶0 - 10

MOTION OSD Select the motion OSD: ▶ON, OFF

TEXT ALARM Select the motion text display: ▶ON, OFF

<IMAGE> Mode

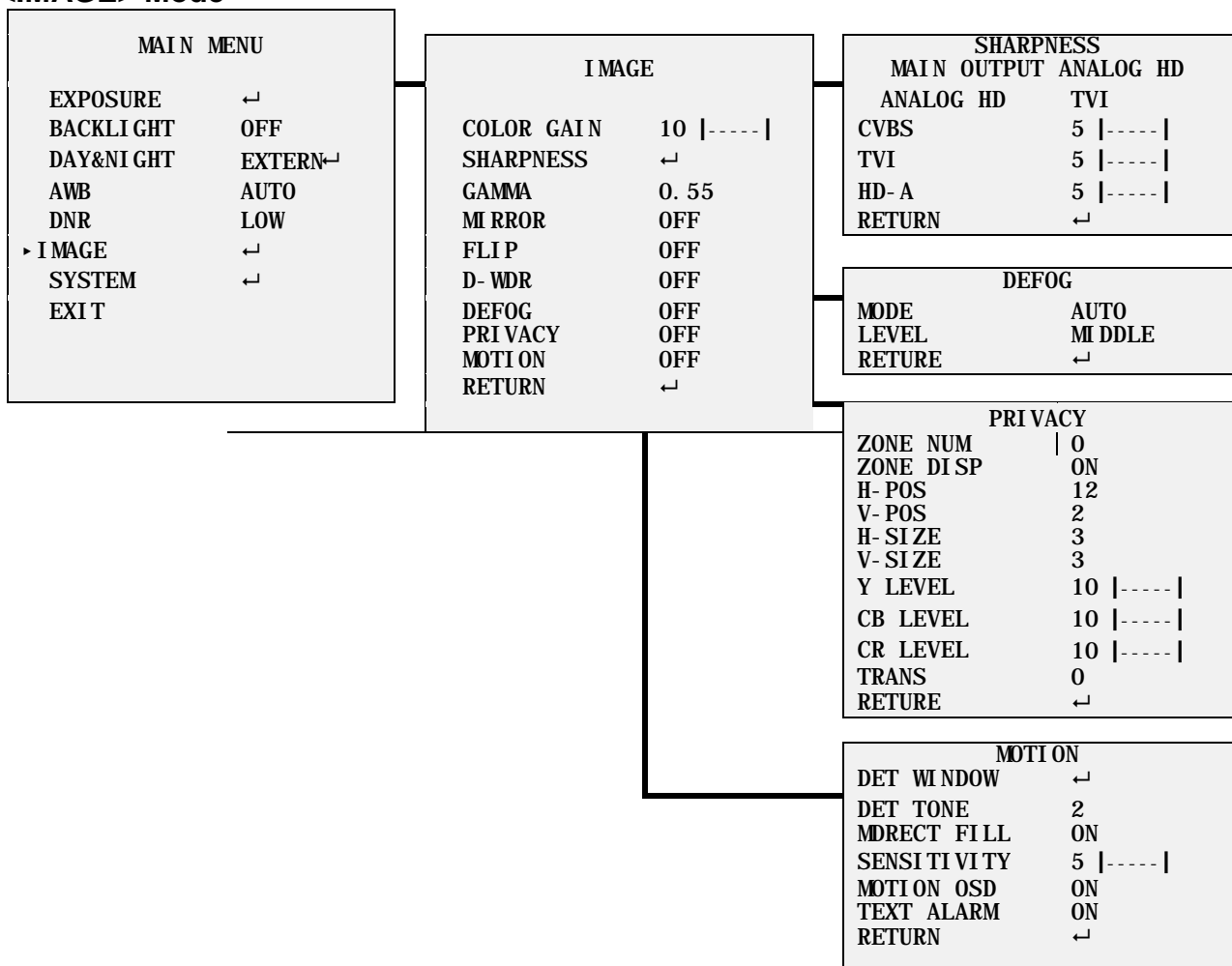

SYSTEM

The SYSTEM menu provides the ability to adjust the OUTPUT, FRAME RATE, FREQ, LANGUAGE, SETUP and RESET functions of the camera.

1) **OUTPUT** Select the output mode and control.

- MAIN OUTPUT:** ANALOG HD, ANALOG OUT1
- ANALOG HD:** TVI, HD-A
- ANALOG OUT:** CVBS
- Y GAIN** Adjust the Y gain: 0 ~ 255
- CB GAIN** Adjust the CB gain: 0 ~ 255
- CR GAIN** Adjust the CR gain: 0 ~ 255
- POSITION** Adjust the position: 0 ~ 255
- BURST FREQ** Adjust the burst frequency: 0 ~ 255
- BURST GAIN** Adjust the burst gain: 0 ~ 255
- B&W** Select the B&W mode burst on/off:
 BURST ON, BURST OFF
- TVI_UTC** Select the TVI_UTC Protocol ▶Hikvision-C, Pelco-C
(UTC – Up the Coax)

2) **FRAME RATE:** Select the frame rate: 1080 30P, 720 30P, 720 60P

3) **FREQ:** Select the frequency: 60Hz, 50Hz

4) **LANGUAGE:** OSD menu LANGUAGE: ENG, CHN, CHN(S), JPN, KOR

5) **SETUP:** Set the camera version.

CAM VERSION: Select the camera version

SAVE: Save the user setting value

6) **RESET:** Factory initialization of camera settings

<SYSTEM> Mode

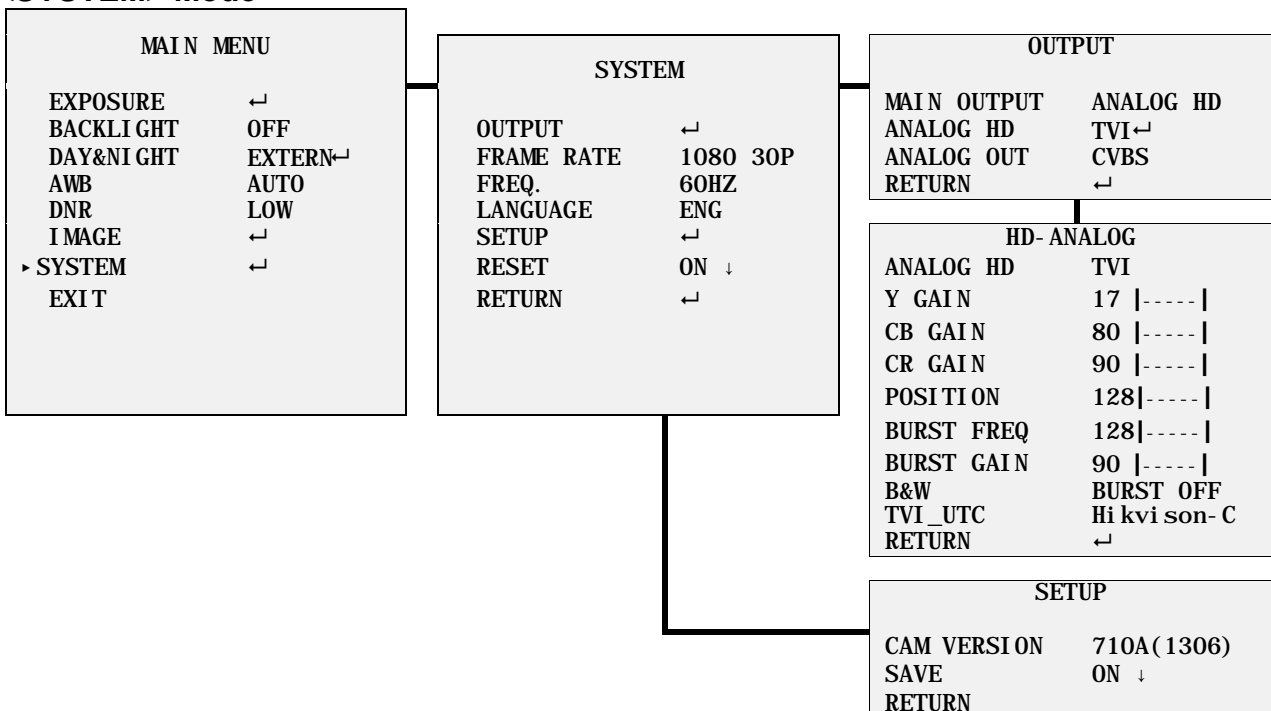

SPECIFICATION

MODEL		V672-W-NL Box Camera	
Power	Power Source	24 VAC \pm 10%/12 VDC \pm 10%	
	Power Consumption	Max 3.0 Watts (250mA)	
General	Image Sensor	1/2.8" 2.1M Sony CMOS	
	Total Pixels	1945(H) x 1109(V)	
	Active Pixels	1937(H) x 1097(V)	
	Scanning System	16:9 Progressive	
	Sync. System	Internal	
	Video Frame Rate	1920x1080p@30 fps; 1920x1080p@25 fps	
	CVBS Resolution	700 TVL	
	Min. illumination	0.03 lux (color) at DSS off	
	Video Output	BNC 1 (TVI/AHD selectable)/BNC 2 (CVBS)	
	Camera Control	OSD Menu (joystick switch, coaxial control)	
	S/N Ratio	More than 52dB (AGC off)	
Function	Lens		DC (ALC) / MANUAL (ELC)
	Exposure	Shutter	AUTO/FLICKER/MANUAL(1/30(25)~1/30,000) sec
		AGC	1 ~ 10
		Sens-UP	OFF/x2/x4/x8/x16/x32
		Brightness	1 ~ 20
		D-WDR	OFF/ON (composite mode)
		Defog	OFF/ON
	Backlight		OFF/HLC/BLC/WDR (true WDR in HD mode)
	White Balance		AUTO (Indoor)/AUTOext (Outdoor)/PRESET/MANUAL
	Day & Night		AUTO/COLOR/B&W/EXTERN
	DNR		OFF/LOW/MIDDLE/HIGH
	S P E C I A L	Sharpness	0 ~ 10
		Mirror	OFF/ON
		Flip	OFF/ON
		Shading	OFF/ON
		Motion Detection	OFF/ON (4 zone)
		Privacy Masking	OFF/ON (16 zone)
Language		ENG/CHN/CHN (S)/JPN/KOR	
Video mode		60Hz (NTSC)/ 50Hz (PAL)	
EXIT		EXIT (Auto Save)	
Connector & ETC	Power input	Terminal Block	
	Video output	BNC 1 connector (TVI/AHD)/BNC 2 connectors (CVBS)	

Transmission Distance	Over 500m via 5C-2V coaxial cable
Auto Iris Output	4-pin mini din jack (standard connection)
Lens	C/CS mount (selected through back focus)
Operating temperature	14°F ~ 122°F (-10°C ~ +50°C)
Operating humidity	0 ~ 96% (non-condensing)
External dimension (WxHxD)	2.6 x 2.2 x 4.7 in. (66 x 56 x 120 mm)
Weight	1.04 lb (470g)

* Specifications are subject to change without notice *

Shipping Instructions

Use the following procedure when returning a unit to the factory:

1. Call or write Vicon for a Return Authorization (R.A.) at one of the locations listed below. Record the name of the Vicon employee who issued the R.A.

Vicon Industries Inc.
135 Fell Court
Hauppauge, NY 11788
Phone: 631-952-2288; Toll-Free: 1-800-645-9116; Fax: 631-951-2288

For service or returns from countries in Europe, contact:

Vicon Industries Ltd
Unit 4, Nelson Industrial Park,
Hedge End, Southampton
SO30 2JH, United Kingdom
Phone: +44 (0)1489/566300; Fax: +44 (0)1489/566322

2. Attach a sheet of paper to the unit with the following information:
 - a. Name and address of the company returning the unit
 - b. Name of the Vicon employee who issued the R.A.
 - c. R. A. number
 - d. Brief description of the installation
 - e. Complete description of the problem and circumstances under which it occurs
 - f. Unit's original date of purchase, if still under warranty
3. Pack the unit carefully. Use the original shipping carton or its equivalent for maximum protection.
4. Mark the R.A. number on the outside of the carton on the shipping label.

Vicon Standard Equipment Warranty

Vicon Industries Inc. (the "Company") warrants your equipment to be free from defects in material and workmanship under Normal Use from the date of original retail purchase for a period of three years, with the following exceptions:

1. All IQEYE Cameras: Two years if purchased before 1/1/2011.
2. Alliance-mini (IQD3xx), Alliance-mx (IQMxxx) and 3 Series (IQ03xx): Five years if purchased between 1/2/2011 – 12/31/2014.
3. Alliance-Pro (IQA3xx): Five years if purchased between 3/2/2012 – 12/31/2014. Three years if the motorized lens (IQA3xx-A3) option.
4. Access Control System Components: Two year from date of original retail purchase.
5. Uninterruptible Power Supplies: Two years from date of original retail purchase.
6. VDR-700 Recorder Series: One year from date of original retail purchase.
7. V5616MUX: One year from date of original retail purchase.
8. Arecont Cameras: One year from date of original retail purchase.
9. FMC series fiber-optic media converters and associated accessories: Lifetime warranty.
10. For PTZ cameras, "Normal Use" excludes prolonged use of lens and pan-and-tilt motors, gear heads, and gears due to continuous use of "autopan" or "tour" modes of operation. Such continuous operation is outside the scope of this warranty.
11. Any product sold as "special" or not listed in Vicon's commercial price list: One year from date of original retail purchase.

NOTE:

- If the product is to be used outdoors or in dusty, humid, or other hostile environments, it must be suitably protected.
- Camera products must be protected, whether in use or not, from exposure to direct sunlight or halogen light as the light may damage the camera image sensor. This applies to both indoor and outdoor use of the cameras.
- For camera products supplied without a lens, extreme care should be used when mounting a lens on these products. Damage to the product due to incorrectly mounted lenses will invalidate this limited hardware warranty.
- Failure to comply with any of the aforementioned requirements will invalidate this Limited Hardware Warranty.

Date of retail purchase is the date original end-user takes possession of the equipment, or, at the sole discretion of the Company, the date the equipment first becomes operational by the original end-user.

The sole remedy under this Warranty is that defective equipment be repaired or (at the Company's option) replaced, at Company repair centers, provided the equipment has been authorized for return by the Company, and the return shipment is prepaid in accordance with policy. Repaired or replacement hardware will be warranted for the remainder of the original Warranty Period or ninety (90) days, whichever is longer. When a product or part is exchanged the replacement hardware becomes the property of the original purchaser and all hardware or part thereof that is replaced shall become the property of Vicon.

The warranty does not apply (a) to faulty and improper installation, maintenance, service, repair and/or alteration in any way that is not contemplated in the documentation for the product or carried out with Vicon consent in writing, operation adjustments covered in the operating manual for the product or normal maintenance, (b) to cosmetic damages, (c) if the product is modified or tampered with, (d) if the product is damaged by acts of God, misuse, abuse, negligence, accident, normal wear and tear and deterioration, improper environmental conditions (including, but not limited to, electrical surges, water damage, chemical exposure, an/or heat/cold exposure) or lack of responsible care, (e) if the product has had the model or serial number altered, defaced or removed, (f) to consumables (such as storage media or batteries) (g) to products that have been purchased "as is" and Vicon the seller or the liquidator expressly disclaim their warranty obligation pertaining to the product, (h) to any non-Vicon hardware product or any software (irrespective of packaged or sold with Vicon hardware product) and Vicon products purchased from an unauthorized distributor/reseller, (i) to damage that occurs in shipment or (j) to damages by any other causes not related to defective design, workmanship and/or materials.

The warranty for the products shall run from Vicon to End User customers only (including product purchased through authorized partners and resellers). Vicon is not obligated under any circumstances to honor warranties on product(s) purchases from internet auction sites including eBay, uBid or from any other unauthorized resellers. Except as explicitly provided herein, Vicon disclaims all other warranties, including the implied warranties of fitness for a particular purpose and merchantability.

Software supplied either separately or in hardware is furnished on an "As Is" basis. Vicon does not warrant that such software shall be error (bug) free. Software support via telephone, if provided at no cost, may be discontinued at any time without notice at Vicon's sole discretion. Vicon reserves the right to make changes to its software in any of its products at any time and without notice.

The Warranty and remedies provided above are exclusive and in lieu of all other express or implied warranties including, but not limited to, the implied warranties of merchantability or fitness for a particular purpose. Certain jurisdictions do not allow the exclusion of implied warranties. If laws under such jurisdictions apply, then all express and implied warranties are limited to the warranty period identified above. Unless provided herein, any

statements or representations made by any other person or firm are void. Except as provided in this written warranty and to the extent permitted by law, neither Vicon nor any affiliated shall be liable for any loss, (including loss of data and information), inconvenience, or damage, including, but not limited to, direct, special, incidental or consequential damages, resulting from the use or inability to use the Vicon product, whether resulting from breach of warranty or any other legal theory. Notwithstanding the foregoing, Vicon total liability for all claims under this warranty shall not exceed the price paid for the product. These limitations on potential liabilities have been an essential condition in setting the product.

No one is authorized to assume any liability on behalf of the Company, or impose any obligations on it in connection with the sale of any Goods, other than that which is specified above. In no event will the Company be liable for indirect, special, incidental, consequential, or other damages, whether arising from interrupted equipment operation, loss of data, replacement of equipment or software, costs or repairs undertaken by the Purchaser, or other causes.

This warranty applies to all sales made by the Company or its dealers and shall be governed by the laws of New York State without regard to its conflict of laws principles. This Warranty shall be enforceable against the Company only in the courts located in the State of New York.

The form of this Warranty is effective August 1, 2015.

THE TERMS OF THIS WARRANTY APPLY ONLY TO SALES MADE WHILE THIS WARRANTY IS IN EFFECT. THIS WARRANTY SHALL BE OF NO EFFECT IF AT THE TIME OF SALE A DIFFERENT WARRANTY IS POSTED ON THE COMPANY'S WEBSITE, *WWW.VICON-SECURITY.COM*. IN THAT EVENT, THE TERMS OF THE POSTED WARRANTY SHALL APPLY EXCLUSIVELY.

Vicon part number: 8006-9010-03-12 REV 0815



VICON INDUSTRIES INC.

For office locations, visit the website: www.vicon-security.com

